

Figure 1

# Hydrajaws 2000 Pull-Out Tester

***It is essential that the operating instructions are read before the tester is operated for the first time.***

***Always keep these operating instructions together with the tester.***

***Ensure that the operating instructions are with the tester when it is given to other persons.***

Pull-out tester (Figure 1)

1. Handle grip
2. Operating handle
3. Quick release coupling when fitted or gauge (3a)
4. Movement or displacement indicator scale
5. Load jaw
6. Hexagon operating nut

**Warning! Read the instructions before use!**

The numbers refer to the illustrations, which can be found on the foldout cover pages. Keep these pages open while you read the operating instructions.

## CONTENTS

Description	1
General Operating Instructions	3
Safety Eyebolt Tester Kit MkII	4
Scaffold Tester	7
Care of Tester	9
The Hydrajaws Wall Tie Tester Kit	10
Hydrajaws Material Bond Tester	11

## DESCRIPTION

The model 2000 pull-out tester is a purpose made system for testing fixings, fasteners and anchors. It consists of a mechanical screw arrangement acting through a hydraulic load cell, which measures the load applied to the fixing directly. The resulting load value is then indicated on the dial type gauge or optional digital gauge.

The tester has a built in movement indicator scale 50mm standard or 100mm option, to show "first movement" on the fixing prior to the test load being applied. The tester is supplied as an integral part of the standard tester kit, deluxe kit, master kit, deluxe master kit, scaffold ringbolt and anchor kit, safety harness eyebolt kit, wall tie kit and the material bond tester kit.

A comprehensive range of accessories is also available, further increasing the scope of possible testing applications.

## USE OF THE TESTER AS DIRECTED

The tester is intended for use by skilled personnel with the appropriate training and knowledge of the applicable safety precautions.

## SAFETY RULES

- Modification of the tester, or tampering with its parts is not permissible.
- Observe the information printed in the operating instructions applicable to operation care and maintenance.
- The tester and its accessories may present hazards when used incorrectly by untrained personnel or not as directed.
- Use only the genuine hydrajaws accessories or ancillary equipment listed in the operating instructions.



Read the operating instructions before use



# GENERAL OPERATING INSTRUCTIONS

## Basic tester kit Deluxe tester kit

### Testing procedure using accessories

See Fig 2 on back fly leaf

### Testing procedure using the bolt tester adaptor

See Fig 2 on back fly leaf

1. Fit the appropriate button to the fastener to be tested.

2. Slide the slot in the bolt tester adaptor (18) over the button adaptor until the fastener axis and bolt tester axis are in alignment.

3. Adjust the length of the threaded legs until the head of the bolt tester adaptor can be passed through the opening in the load spreading bridge. Check that the head of the load spreading bridge is centered in the tester and the button adaptor is square in the u shaped slot in the puller. Make final adjustments so that the bolt tester adaptor, tester and fixing are aligned.

4. Position the tester so that the gauge can be easily read.

5. Adjust the length of the threaded legs so that all three are in contact with the base material and the load spreading bridge is aligned and level by referring to the bubble levels on each face.

6. Set the red pointer on the gauge to zero – hold the tester by the grip handle and proceed to load the fastener by turning the operating handle clockwise.

### Caution

Hold the tester securely by the grip handle as long as the fastener is under load. When the load increases, note the reading on the displacement scale on the tester. Indication of failure of the fastener may be obtained by comparing the current reading with the original reading.

7. Increase the load until the required test load is attained. Hold this load and observe any falling back of the gauge pointer which would indicate movement and possible failure of the fastener. Record the satisfactory result.

8. Release the load on the fastener by turning the operating handle anti-clockwise and allowing the test jaw to return to the original position.

9. Remove the tester and bolt tester adaptor.

## USING THE BOLT TESTER ADAPTOR

See Fig 3 and Fig 4 on back fly leaf

The bolt tester adaptor is used either with threaded or slotted button adaptors or by directly engaging an M16 nut in the pulling jaw. It consists of a cylindrical section containing the slotted jaw and an M12 threaded rod. The M12 threaded rod can be fixed permanently to the tester via the M12 locking adaptor placed in the tester jaw or by using the M12 threaded button adaptor. When using the bolt tester adaptor it is a requirement to have a load spreading bridge or stool attached to the tester.

## USING THE THREADED BUTTON ADAPTORS

### M4, M5 M6, M8, M10 & M12

See Fig 5 on back fly leaf

For testing threaded fixings make sure that the button adaptor has at least 2 complete thread turns on the fixing and is secure. If the length of threaded protruding is sufficient, the fastener may be tested without first removing the component fastened. Use with the bolt tester adaptor and load spreading bridge.

## USING THE SLOTTED BUTTON ADAPTORS

### 4.5, 5.5, 6.5, 8.5, 10.5 & 12.5mm

See Fig 6 on back fly leaf

For testing fixings where a connection is made underneath the head of the fixing or anchor in place of the item usually fastened. Use with the bolt tester adaptor and a load spreading bridge.

## USE OF THREADED ROD ADAPTORS

See **Fig 7** on back fly leaf

The M5 and M6 threaded rod adaptors are equipped with an external M12 thread for use in conjunction with the M12 threaded button adaptor. They are used primarily for testing remedial wall ties. The M8 and M10 threaded rod adaptors are equipped with an M16 external thread and the M16 nut fitted with connects to the pulling slot in the tester or bolt tester adaptor.

1. Connect the threaded rod adaptor complete with the M12 button adaptor to the thread on the fixing.
2. Adjust the length of the bridge legs and the height of the button adaptor / nut so that the adaptor can be passed through the hole in the load spreading bridge fitted to the tester and into the pulling jaw.
3. Adjust the threaded legs to minimise any play between the adaptor and the pull tester and ensure that the pull-out force acts along the axis of the fixing being tested.

## USING THE THREADED STUD ADAPTORS

### M10, M12, M16 & M20

See **Fig 8** on back fly leaf

Suitable for testing sleeve and stud anchors. After the anchor has been set in accordance with the manufacturers recommendations, a suitable threaded rod is screwed into the anchor and the adaptor then fitted. The length of the threaded rod to be screwed into the anchor must be at least equal to the diameter of the anchor. When the adaptor is securely fitted to the anchor thread position, place the tester fitted with a load spreading bridge over the adaptor, passing the head through the hole in the bridge and engage it in the pulling jaw of the tester. Level the load spreading bridge with the screwed legs and swivel feet before commencing the application of the load.

See **Fig 9** on back fly leaf

## USING THE RATCHET ATTACHMENT NUT (22MM AF)

See **Fig 10** on back fly leaf

1. Unscrew and remove the standard turning handle, take care to avoid removing the underlying washer and bearing.
2. Refit the M22 A/F operating nut in place of the turning handle.

This nut can then be used with a 22mm ratchet for better access in confined spaces and for easier operation.

## SCAFFOLD

See **Fig 11** and **Fig 12** on back fly leaf

## SAFETY HARNESS EYEBOLT

See **Fig 13** and **Fig 14** on back fly leaf

## SAFETY HARNESS EYEBOLT TESTER KIT MK II

For testing Safety Harness Eyebolts to the requirements of BS5845 and BS EN795 "Protection Against Falling From A Height, Anchor Devices – Requirement for Testing and BS 7883: 2005 BS 788: 2005 code of practice for Design, Selection, Installation, Use and Maintenance of Anchor Devices conforming to BS En 795. The kit may also be used for testing Ladder Restraint Hooks and most Ringbolts in concrete or masonry. The Safety Harness Eyebolt Tester Kit MKII includes the following:

- 2000 model Medium Duty Tester with \* fixed Gauge to 15kN
- 150mm Load Spreading Bridge
- 75mm Hex Extension Legs (3)
- M12 Ringbolt Adaptor with Locking Adaptor
- M22 AF Operating Nut
- Calibration Certificate
- Padded Carrying Case

\* Some models have removable gauge and coupler system

The Tester is factory assembled with the ringbolt adaptor screwed into the M12 locking adaptor located in the Tester jaw and the 150 load spreading bridge with the three 75mm hexagon legs with swivel feet.

## TESTING A SAFETY HARNESS EYEBOLT

Place the bridge over the eyebolt to be tested. Locate the clevis on the eyebolt and fit the cross pin through the clevis and eyebolt, ensuring that the ball on the pin clicks into place, having passed through the second fork.

Adjust the swivel feet by unscrewing from the hexagon leg, so that each foot is resting on the material around the eyebolt and the bridge is square and level. Fit a protection plate between wall and bridge feet if necessary, to protect soft decorative finishes.

Check that the black gauge pointer is resting on zero and set the red maximum indicator pointer to zero, by turning the knob on the gauge window anti-clockwise.

Commence the test by turning the operating handle on the tester clockwise and observe the gauge as the load on the eyebolt is increasing. Continue

applying the load until the proof test load of 6kN is reached with the black gauge pointer. Stop applying the load and observe if the black pointer falls back, leaving only the red pointer at the maximum load achieved.

If the fall back is minimal, apply the load again until both pointers are at the proof test load and the structural anchorage should then sustain the force for a minimum of 15 seconds.

**NOTE** When using the tester in a confined space, it may be impossible to turn the operating handle through 360°. The 22mm A/F operating nut should then be fitted and a suitable socket and ratchet used to turn the nut and apply the test load.

### TO FIT M22 A/F OPERATING NUT

Turn the operating handle anti-clockwise and remove, taking care not to remove the washer and bearing below. Re-fit M22 A/F nut.

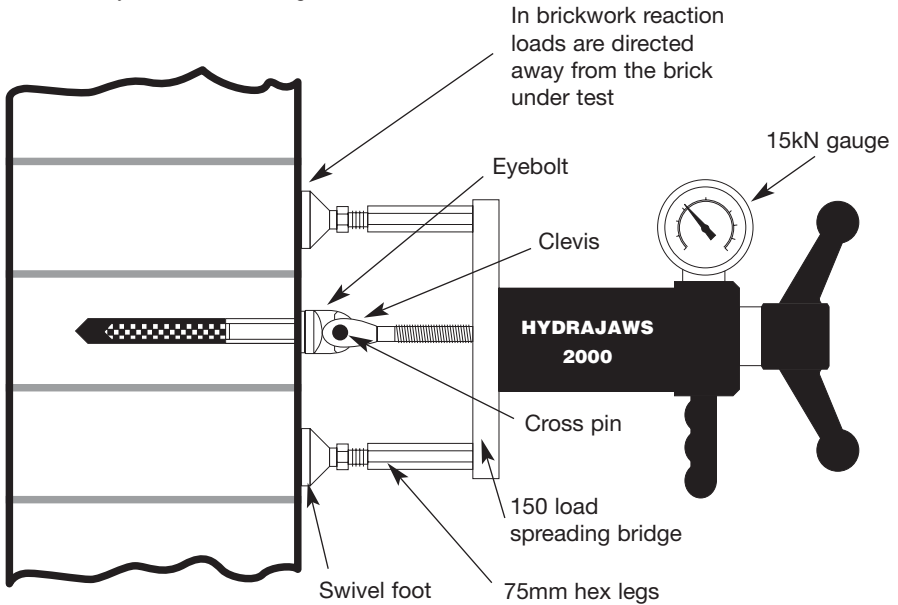

### ABOVE: Tension testing Safety Harness Eyebolts to BS EN795 and BS 7883 in concrete or masonry using Hydrajaws Eyebolt Tester Mk II

Assemble test rig as shown. Ensure hex legs are firmly screwed to bridge. Check that the clevis is fully engaged in the clevis adaptor within the tester body.

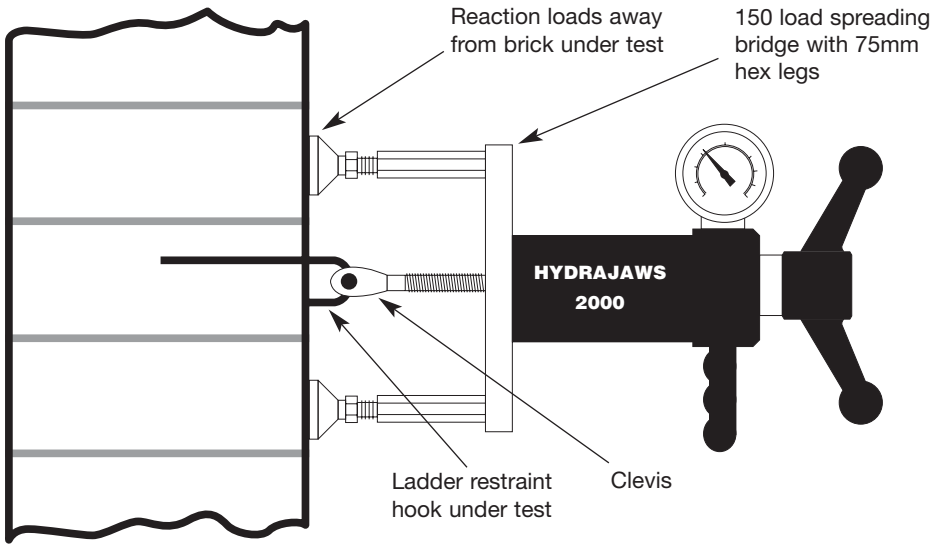

**ABOVE: Test rig arrangement**

Assemble test rig as shown. Ensure hex legs are firmly screwed to bridge. Check that the clevis is fully engaged in the clevis adaptor within the tester body.

**TESTING LADDER RESTRAINT HOOKS**

Follow the same setting up procedure as for s Safety Harness Eyebolt test above, and apply the load gradually until the required proof load of 2.5kN is reached or failure occurs. Observe if the hook withdraws from the structure or the test load cannot be achieved. This would be considered a failure and must be taken out of service.

## SCAFFOLD TESTER

The Hydrajaws Test meter is part of a purpose made system for testing fixings and measures the load supplied. The Scaffold Tester Kit has accessories designed to test Scaffold Anchors and Ringbolts to the requirements of the guidance note TG4-04 issued by National Access and Scaffolding Confederation (NASC) and the Construction Fixings Association (CFA).

The Scaffold Tester Kit includes the following:

- 2000 model Medium Duty Tester with \* fixed Gauge to 20kN
- 150mm Load Spreading Bridge
- 75mm Hex Extension leg (3)
- M16 Hex Setscrew
- Bolt Tester Adaptor
- M12 Ringbolt Adaptor
- M12 Locking Adaptor
- Calibration Certificate
- Padded Carrying Case

\*Some models have removable gauge and coupler system

The Tester is factory assembled with the bolt tester adaptor screwed into the M12 locking adaptor located in the Tester jaw, and the three 75mm hexagon legs with swivel feet fixed to the 150 load spreading bridge.

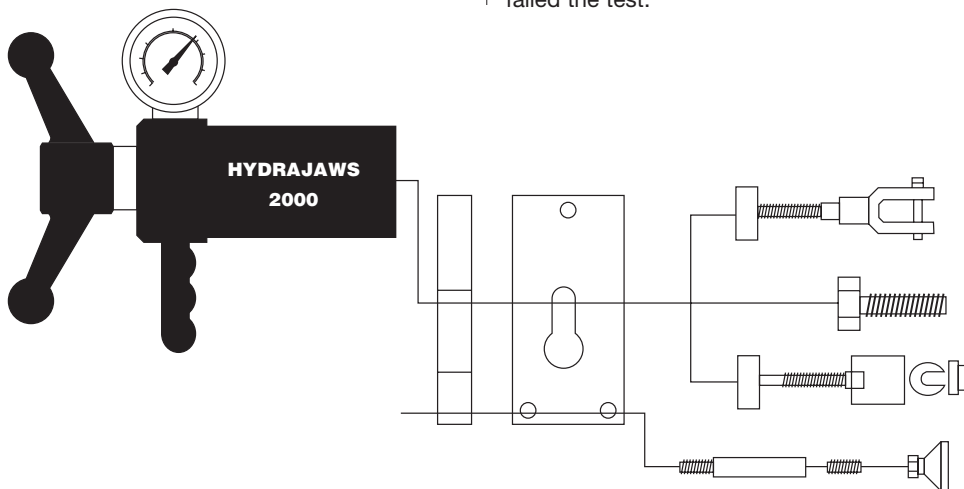

## TESTING OF M16 DROP IN SCAFFOLD TIE ANCHORS

Fit the M16 hexagon setscrew to the anchor, ensuring at least two complete turns for ample thread engagement. Offer Tester with bridge to the hexagon head of the setscrew and engage head in bolt tester adaptor jaw. Make adjustment on each swivel foot by unscrewing from the hexagon extension legs so that each foot is resting on the material around the anchor and the bridge is square and level. Check that the black gauge pointer is resting on zero and set the red maximum indicator pointer to zero by turning the knob on the gauge glass anti-clockwise.

Commence the test by turning the operating handle on the Tester clockwise and observe the gauge as the load on the anchor is increasing. Continue applying the load until the proof test load is reached (kN) with the black gauge pointer. Stop applying the load and observe if the black pointer falls back, leaving the red pointer at the maximum load achieved. If the fall back on the black pointer is minimal, apply the load again until both pointers are at the test load required and leave the test load in place for approximately 10 seconds.

Should the black pointer not reach the maximum test load requirement, or the operating handle has to be turned to maintain the load, it is certain that the anchor will have failed the test.

## TESTING OF EYE TYPE ANCHORS

Unscrew the bolt tester adaptor from the M12 locking adaptor in the Tester jaw and replace it with the ringbolt adaptor clevis. Ensure that at least 2 complete clockwise turns are made to safely engage the threads. Remove crosspin from the clevis and offer the Tester and bridge to engage eye of the anchor in the clevis. Some adjustment will be required on the swivel feet, so that this fit is achieved, push clevis pin through the clevis and eyebolt, ensuring that the ball on the pin clicks into place, having passed through the second fork. Commence the test as described for drop in anchors.

**Note:** Longer Scaffold Eyebolts used in timber frame construction can be tested. But extra long extension legs are required – not supplied in standard kit.

The new NASC/CFA Guidance Note TG4:04\* “Anchorage Systems for Scaffolding” sets out requirements for PRELIMINARY TESTS of scaffold anchors (to check the suitability and allowable loads of an anchor type in a particular base material) and PROOF TESTS

(sample tests to check that anchors have been installed correctly – to be carried out on all jobs). The new Proof Load testing requirement is for a tensile test of 1.5 x the design load. The Hydrajaws Scaffold Tester Kit will test all of these types to a maximum tensile load of 20kN.

TG4:04 also describes six types of anchor most commonly used for anchoring scaffold ties. The Hydrajaws Scaffold Tester Kit will test all of these types to a maximum tensile load of 20kN.

The Hydrajaws Scaffold Tester Kit has recently been revised and now comprises:

- Series 2000 tension tester with fixed gauge calibrated to 20kN
- 150mm load spreading bridge
- 75mm Hex Legs
- Bolt tester adaptor
- M16 Hex Setscrew
- M12 Clevis Adaptor with Locking Adaptor
- Calibration certificate

\* TG4:04 can be downloaded free of charge from the CFA website at [www.fixingscfa.co.uk](http://www.fixingscfa.co.uk)

### Test rig arrangements for:

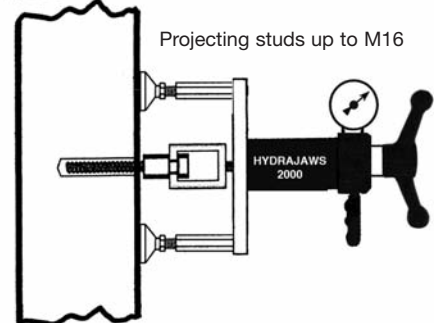
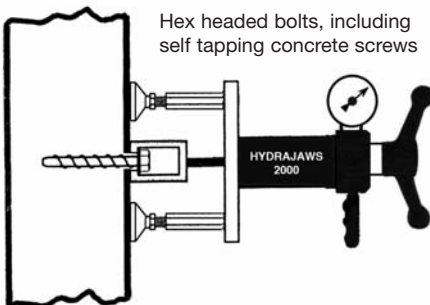
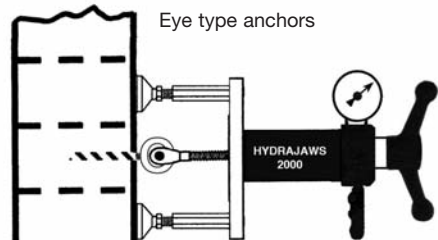
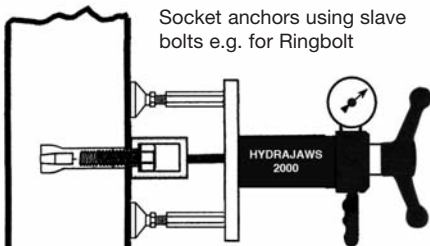

## CARE OF TESTER

Unscrew and remove operating handle. Take care to avoid moving the washer and bearing below. Grease surfaces and threads before re-assembly.

Some Testers have a removable gauge connected via a hydraulic coupler. Frequent removal and reconnection to the gauge will cause the oil reservoir level to drop and will eventually affect the amount of oil available to operate the gauge. When this happens, the oil piston between the operating handle and the black tester body will have retracted within the body.

## TO FILL THE TESTER WITH OIL

### (model with removable gauge only)

Clamp the Tester in a vice with the oil coupler in the vertical position. Connect the oil bottle containing light hydraulic oil to the coupler on the Tester. Force any air out of the system by pushing the piston in fully. Pull on the turning handle until the front of the stainless piston is 10mm from the end of the body. Push this piston back in fully, using thumbs, pull out again and repeat until all air bubbles are expelled into the oil bottle. The piston should be set 10mm from the face of the body to give maximum oil capacity. Remove oil bottle to complete filling operation.

A TESTER WITH A FIXED GAUGE CANNOT BE FILLED WITH OIL BY THE OPERATOR.

**Recommended oil:** light mineral type DTE.

Illustrated filling instructions are on our website [www.hydrajaws.co.uk](http://www.hydrajaws.co.uk)

**From the date of purchase, your tester is calibrated for one year. After this time, the Tester should be returned for calibration.**

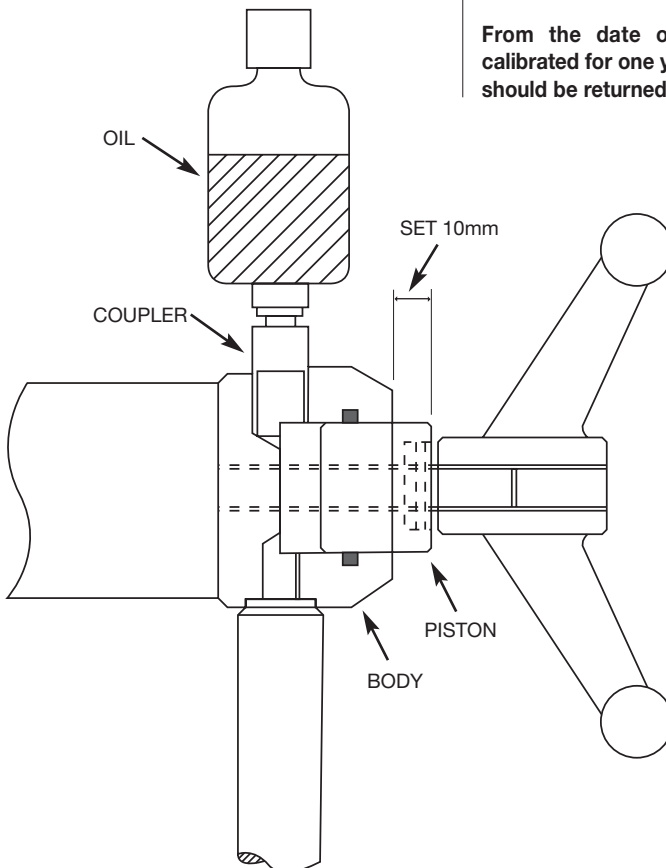

# THE HYDRAJAWS WALL TIE TESTER KIT

See **Fig 7** and **Fig 15** on back fly leaf

## INTRODUCTION

The Hydrajaws Test meter is a purpose made system for testing fixings and consists of a mechanical screw-jack arrangement fitted through a hydraulic load cell which directly, measures the load applied to the fixing. This kit contains a test fitted with a 5kN fixed gauge, a 100mm wall tie spacer bridge and M5 and M6 wall tie adaptors.

## SITE TESTING OF WALL TIES

**Fig 7** and **Fig 15**

The purpose of carrying out site tests on wall ties is either as part of a site survey to investigate the suitability of the base material for the use of a particular tie or during the installation of the ties to verify the quality of the installation.

In accordance with the BBA recommendation on Remedial wall ties it is required that the first 3 ties in a building should be tested followed by 1 tie in every 20 installed. BRE Digest 401 'Replacing wall ties' specifies that the inner end of the first 20 ties installed on a contract should be all proof tested and that a reducing rate of testing is required for the remaining ties, for 21 to 250 ties 10% should be tested, for 251 to 1000 ties 5% should be tested and for more than 1000 ties 2.5% should be tested.

## LOAD PROCEDURE

Generally the loading procedure for testing wall ties is the same for both ends of wall ties regardless of whether they are mechanical and chemical fixings, so the loading procedures which follow. Connect the wall tie adaptor complete with the M12 threaded button adaptor to the end of the wall tie, taking care not to tighten the outer leaf expansion nut. With the test meter securely attached to the Bridge, adjusting the length of the legs on the loading bridge and the position of the button

adaptor if necessary, pass the adaptors through the keyhole slot in the loading bridge and ensure that the button adaptor is centred in the test meter.

Use the levelling screws on the bridge to take up the slack in the system and to ensure that the test meter is axially aligned with the wall tie under test. **DO NOT LOAD THE TIE WITH THE LEVELLING SCREWS.**

See **Fig 7** on back fly leaf.

Position the test meter so that the gauge is in the most convenient place to read it. Set the red pointer at zero. Whilst holding onto the handle on the test meter body, turn the loading handle clockwise to increase the load on the anchor. Note: Do not let go of the tester before the load has been removed. When the load starts to increase note the scale reading on the displacement scale behind the gauge on the test meter body. Keep increasing the load until the required load is achieved. Some indication of the displacement of the Tie can be obtained by comparing the reading from the displacement scaled while the fixing is under load with the first reading noted. To release the load rotate the handle anti-clockwise and push down until the original position is resumed. Lift the test meter off the stud adaptor and unscrew the adaptor and studding.

## PROCEDURE, INNER LEAF

Install the tie into the inner leaf in accordance with the method statement appropriate to the wall tie being used. If appropriate leave the resin mortar to cure for at least the recommended curing time. Load the tie in accordance with the procedure given above. If the displacement of the tie is judged to be excessive then the quality of the fix into the base material is suspect. Remove the testing assembly and complete the installation of the tie in accordance with the appropriate method statement.

## PROCEDURE, OUTER LEAF, MECHANICAL CONNECTIONS

It is not possible to test the outer leaf in isolation on a normally installed tie.

# HYDRAJAWS MATERIAL BOND TESTER

## ON SITE PULL-OFF METHOD

### Equipment required:

- Hydrajaws material bond tester
- 50mm diameter steel dollies (metallic), 5 or more
- 75mm diameter (for concrete or timber), 5 or more
- Adhesive
- Spatula
- Bondline spacers – i.e. ballotini (glass spheres)
- Diamond-coated core drill (if required)

### Procedure for preparing samples for pull-off testing:

1. Clean the steel dollies (degrease and grit blast unless otherwise stated)
  - This will help to prevent interfacial failures at the dolly interface
2. For concrete substrates drill through the repair system with diamond core drill at  $(90\pm)^\circ$  to the surface into the test surface by ~5mm or more
  - This ensures a consistent bond area and will therefore help reduce variations in the test results
3. Clean the substrate test surface as recommended by the manufacturer
4. Mix the adhesive as recommended by the adhesive supplier and add 1% by weight of ballotini (usually 0.5mm unless stated otherwise)
  - Adding ballotini will reduce alignment errors and therefore help reduce variations in the test results
5. Apply adhesive to steel dolly
6. Apply adhesive to substrate test surface
  - This ensures the adhesive wets out both surfaces and helps prevent interfacial failures

7. Press the steel dolly into the substrate test surface with a firm pressure
  - **DO NOT** 'seat' the dolly by twisting it into position. If the dolly is twisted into position it will increase the likelihood of interfacial failures.
8. Remove excess adhesive from around the edge of the dolly without disturbing its position
  - This ensures a consistent bond area and will therefore help reduce variations in the test results
9. If working on a vertical or overhead surface, ensure the dollies are held firmly in position until the adhesive has cured.

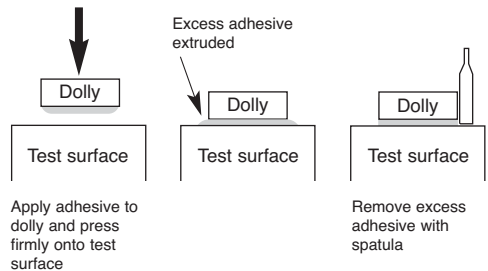

**Fig.1** Procedure for bonding steel dollies onto substrate

### Procedure for performing pull-off tests:

- Set up the pull-off equipment so that the load is applied to the centre of the dolly and at an angle of  $90^\circ \pm$  (Fig.2) Excess misalignment will reduce pull-off strengths
- Secure equipment so that it does not move during testing. This will cause excess misalignment which will reduce pull-off strengths
- Apply a load at a continuous and even rate until failure.
- Record test temperature, failure load and failure mode (Fig.3) (Record mixed failure modes in percentages of bond area, i.e. 90% substrate failure, 10% cohesive failure)

### IMPORTANT

A low reading will be obtained if:

- The pull-off tester is misaligned and not perpendicular to the specimen
- The specimen is misaligned and not perpendicular to the pull-off tester
- The bondline is not of uniform thickness (0.5mm)
- A sudden or erratic loading is applied.

**Note:** This information is for guidance only. Please also refer to adhesive manufacturer's data and safety sheets.

Fig. 2 Test set-up

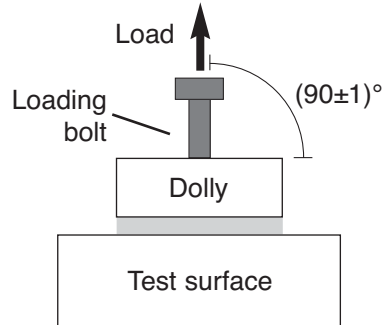

When adhesive has cured pull off dollies and record maximum load

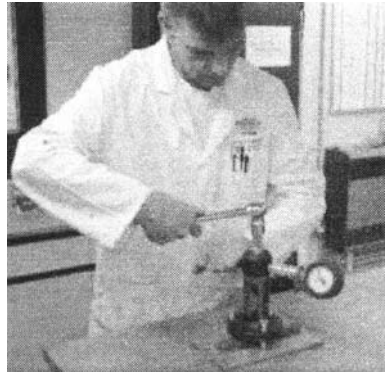
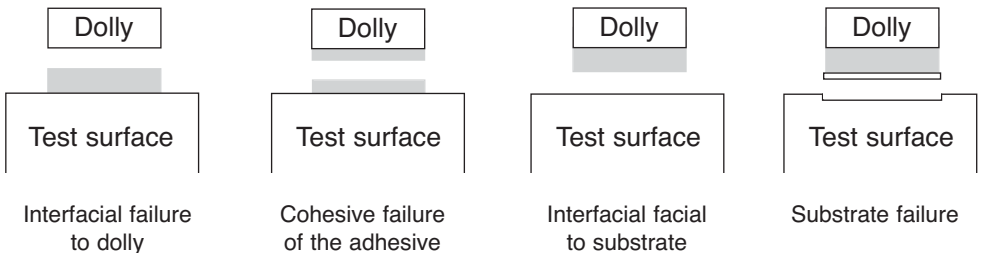

Fig. 3 Possible Modes of failure



# HYDRAJAWS MATERIAL BOND TESTER

Select appropriate disc for test and fix to surface with suitable bonding agent. Connect centering plug to disc using the 8mm thread and hand tighten until bottom plus is flush with top disc. Lower load stool centre hole over centering plug and adjust the 3 screws until top of plug is flush and level with top of stool. It is essential that this levelling is carried out carefully to ensure a square and smooth pull through the stool. Slide Tester over adaptor on top of plug and fit 22mm socket and ratchet to the operating nut. Operate ratchet in a clockwise direction until required loading is obtained or bonding breaks. Maximum loading achieved will be shown by red indicator pointer. Use this reading to calculate the bond strength Mpa from the chart. Replacement discs available in both sizes from stock.

## ACTUAL PULL FORCE READ DIRECT FROM GAUGE

<b>50mm dia Disc Area 1964mm<sup>2</sup></b>	<b>Actual Pull Force</b>	<b>75mm dia Disc Area 4418mm<sup>2</sup></b>
<b>Bond Strength</b>	<b>kN</b>	<b>Bond Strength</b>
<b>MPA</b>		<b>Mpa</b>
0.51	1.00	0.23
1.01	2.00	0.45
1.53	3.00	0.68
2.03	4.00	0.90
2.55	5.00	1.13
3.05	6.00	1.36
3.56	7.00	1.59
4.07	8.00	1.81
4.58	9.00	2.04
5.09	10.00	2.26
5.06	11.00	2.49
6.11	12.00	2.72
6.62	13.00	2.94
7.13	14.00	3.16
7.63	15.00	3.40
8.15	16.00	3.62
8.66	17.00	3.85
9.16	18.00	4.07
9.67	19.00	4.30
10.20	20.00	4.52
10.70	21.00	4.98
11.71	23.00	5.20
12.22	24.00	5.43
12.73	25.00	5.65

Mpa (Mega Pascals)=N/mm squared

Mpa = Actual Pull Force ÷ Area of Disc x 1000

**Hydrajaws® Limited**  
**1 The Courtyard**  
**Roman Way**  
**Coleshill**  
**Birmingham B46 1HQ**

**Telephone +44 (0)1675 430370**  
**Fax +44 (0)1675 465950**

**email: [tester@hydrajaws.co.uk](mailto:tester@hydrajaws.co.uk)**  
**[www.hydrajaws.co.uk](http://www.hydrajaws.co.uk)**

AUG07

Printed by Rotadex Systems, Tel: 0121 783 7411

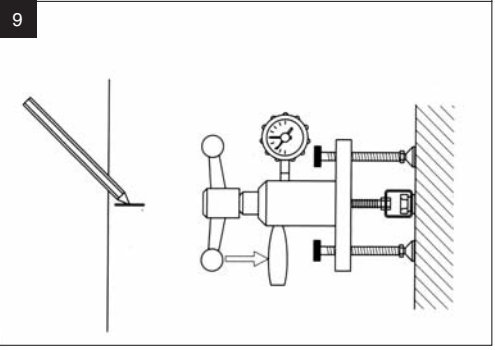
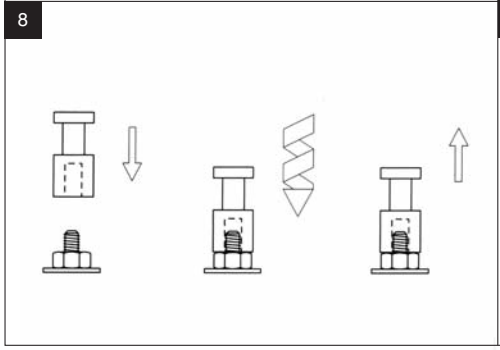
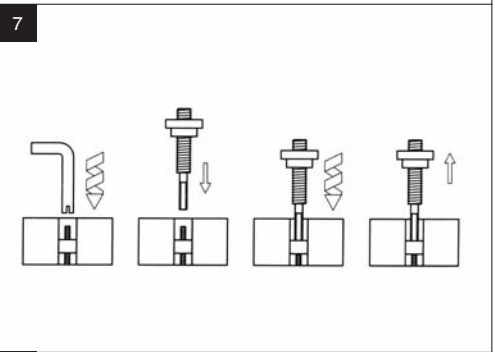
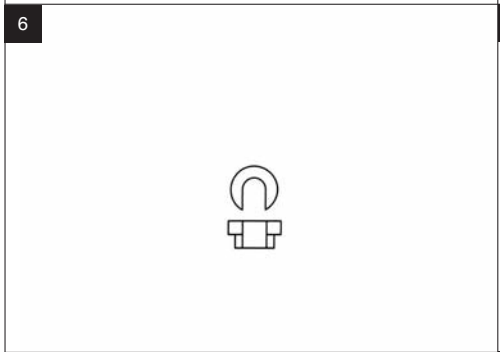
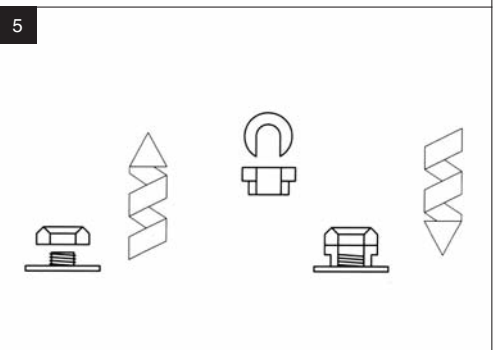
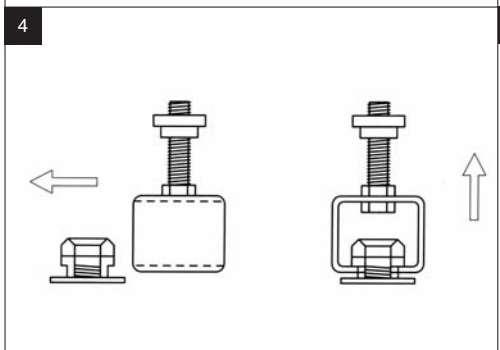
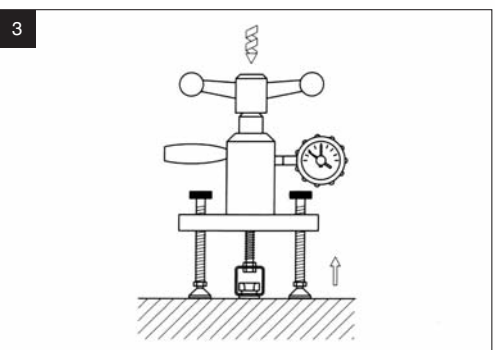
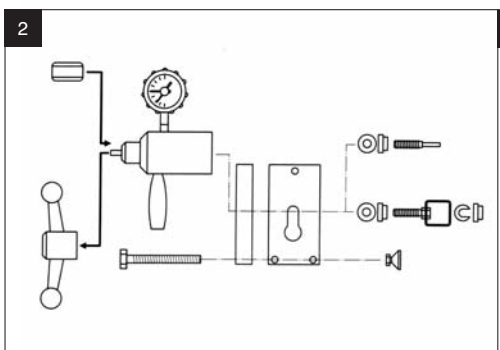

10

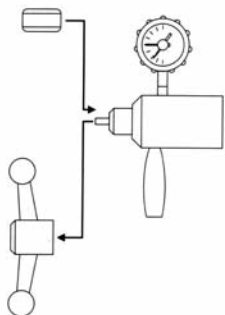

11

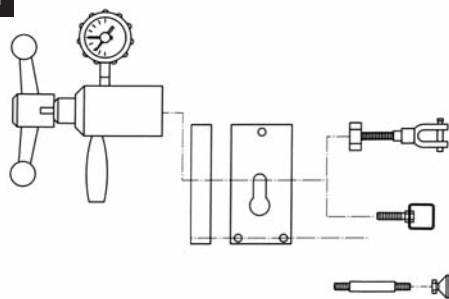

12



13

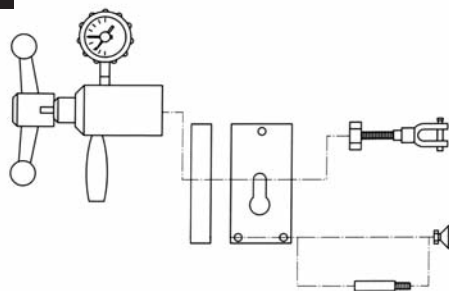

14



15

